

The HP CLJ 3000/3600/3800 Toner Cartridge

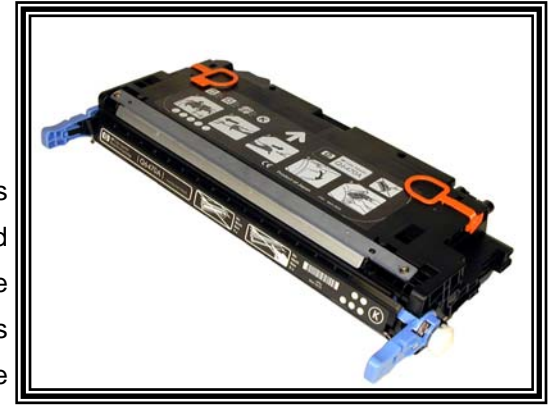

First released in October 2005, the HP-3600 series of color laser printers are based on a 17/22 ppm engine (depending on the machine). The stated speed is for both black and color pages except for the 3000 series where the monochrome pages run at 30ppm and color at 15ppm. These engines have a standard resolution of 600 Dpi (3600 DPI with imageRET). The 3600 cartridges are an all in one type containing the Supply drum and waste. Like the CLJ-2600 these machines use an in-line, or single pass system. All four cartridges are stacked on top of one another and each color develops its own image which is transferred to the paper by the transfer belt. This type of system is faster, and allows for a higher quality print. The 3000 series cartridges use a different plastic shell from the 3600/3800 which prevents them from being used in those machines. The only difference between the 3600 and 3800 color cartridges besides the toner load is the chip. **Figures A & B** show the difference between the CLJ 3000 black cartridge and the CLJ 3600 black cartridge. All three series of machines in this engine have cartridges that use HP's new "ColorSphere" toner. This is a new more vibrant toner and is the second generation of chemical toner for HP.

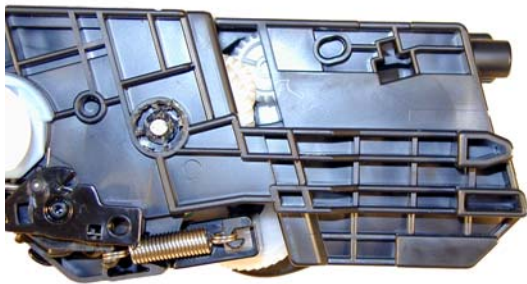

Figure A

The chips in these cartridges work the same as most other HP color cartridges, the chip does not need to be changed in order for the cartridge to work. The toner low circuitry will be disabled, but after the user presses the "SELECT" button, the cartridge will work. The display will then alternate from "READY" to "Unauthorized Supply in Use". The chips in these machines are similar in size to the HP-2600 in that they are very small.



Figure B

The printers based on the 3600 engine are the:

- HP Color LaserJet 3000n
- HP Color LaserJet 3000dn
- HP Color LaserJet 3000dtn
- HP Color LaserJet 3600
- HP Color LaserJet 3600n
- HP Color LaserJet 3600dn
- HP Color LaserJet 3800
- HP Color LaserJet 3800n
- HP Color LaserJet 3800dn
- HP Color LaserJet 3800dtn

The cartridges used in the 3000 machines are the:

Q7560A (Black)	6,500 pages at 5%	\$187.00 List
Q7561A (Cyan)	3,500 pages at 5%	\$180.00 List
Q7563A (Magenta)	3,500 pages at 5%	\$180.00 List
Q7562A (Yellow)	3,500 pages at 5%	\$180.00 List

The cartridges used in the 3600 machines are the:

Q6470A (Black)	6,000 pages at 5%	\$184.00 List
Q6471A (Cyan)	4,000 pages at 5%	\$183.00 List
Q6473A (Magenta)	4,000 pages at 5%	\$183.00 List
Q6472A (Yellow)	4,000 pages at 5%	\$183.00 List

Cartridges used in the 3800 machines are the:

Q6470A (Black)	6,000 pages at 5%	\$184.00 List
Q7581A (Cyan)	6,000 pages at 5%	\$237.00 List
Q7583A (Magenta)	6,000 pages at 5%	\$237.00 List
Q7582A (Yellow)	6,000 pages at 5%	\$237.00 List

The black cartridge Q6470A is used in both the 3600 and 3800 machines.

As you can see from these prices (Current as of June 2006), these are very profitable cartridges to remanufacture.

The basic workings of these cartridges is similar to the 2600 series, but some advances have been made. Because of that we are including the cartridge theory here. If you are familiar with the 2600 theory, you will notice that the material here is very similar, these engines just work faster.

HP-3600 Color Printing Theory

The Color toner cartridge printing process happens in a series of stages or steps. For the purpose of this article, we will call them stages. **Figure 1** shows the basic layout of the cartridges and how they relate to one-another and the printer. **Figure 2** shows the cartridge parts layout.

In the first stage, a Pre-exposure LED bathes the drum surface and eliminates any residual charges on the drum surface, the Primary Charge Roller (PCR) then places a uniform negative DC voltage on the OPC drum surface. The amount of the negative DC voltage placed on the drum is controlled by the printer's intensity setting. This is a new system for HP.

REMANUFACTURING THE HP CLJ 3000/3600/3800 TONER CARTRIDGES

In past machines the PCR both erased and charged the drum. Now the PCR only charges it. In theory, this should lead to fewer back grounding problems, but only time will tell. See **Figure 3**

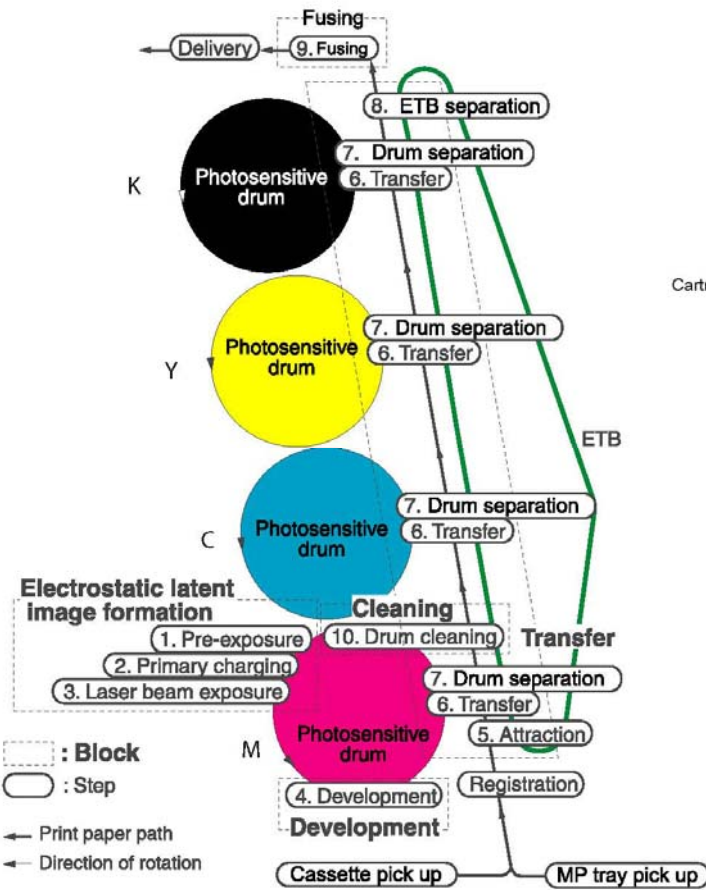

Figure 1

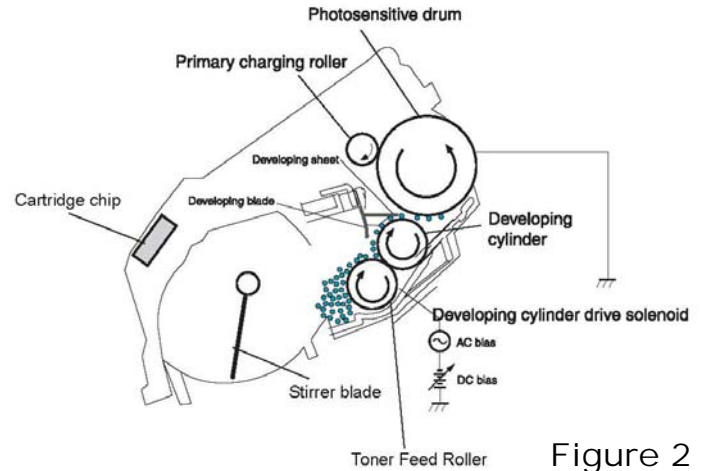

Figure 2

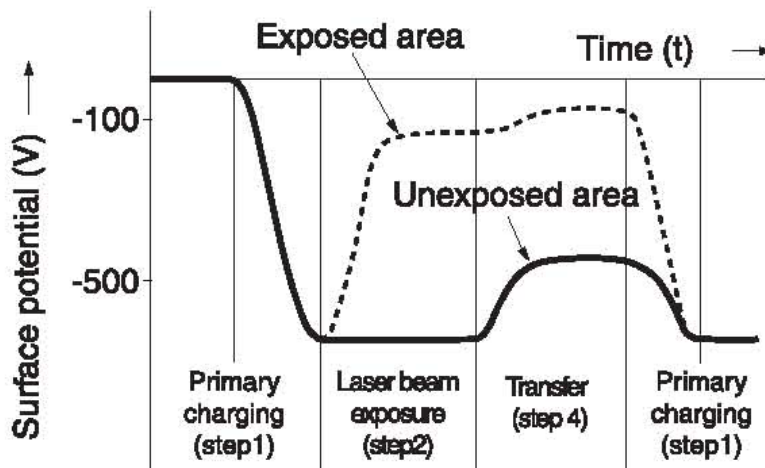

Figure 3

In the second stage, the laser beam is fired onto a rotating mirror (called the scanner). As the mirror rotates, the beam is reflected into a set of focusing lenses. The beam then strikes the drums surface, reducing the negative charge and leaving a latent electrostatic image on the drum. The areas where the laser did not strike the drum will retain the higher negative charge. See **Figure 4**

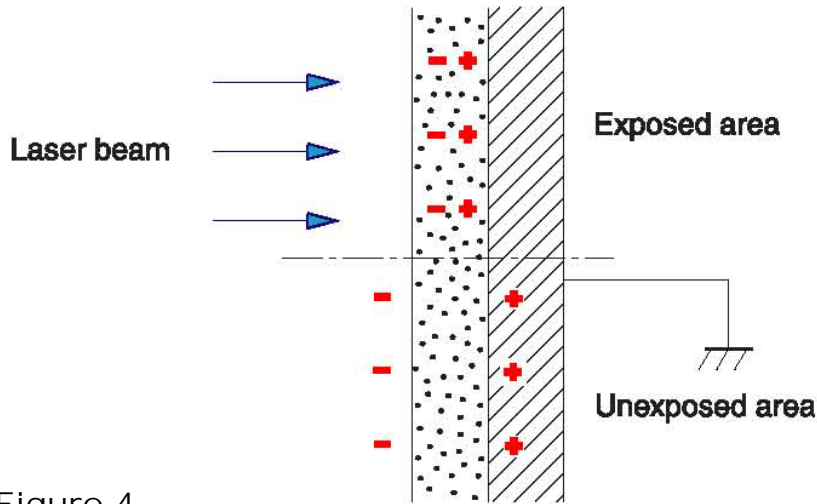

Figure 4

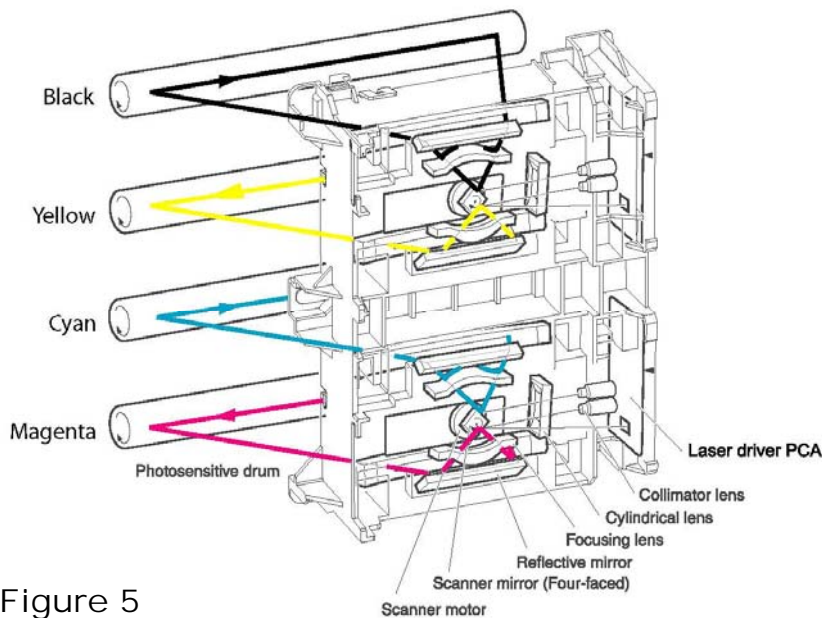

Figure 5

Each color cartridge has its own laser but shares the scanner unit with another color. See **Figure 5**. While this is incredibly complicated, it cuts down on the parts needed per machine, and keeps the cost down. If you ever have a machine that has a scanner problem it will affect 2 color cartridges.

The third or developing stage is where the toner is developed on the drum by the developing section (or supply chamber), which contains the toner particles. The development stage is actually made up of two steps: toner charging, and the actual development. In the toner charging stage, the toner stirring blade turns inside the hopper. As it turns, friction causes a negative potential to develop on the toner. In addition, a foam feed roller brings the toner to the developer roller and also places a negative charge on the toner. These two charges ensure a uniform charge on the toner. Once the toner is properly charged, the toner will coat the developer roller. The toner is also held onto the developer roller by another negative DC bias voltage. This voltage is controlled by the printer's intensity setting, and causes either more or less toner to be attracted by the developer roller. This in turn will either increase or decrease the print density.

REMANUFACTURING THE HP CLJ 3000/3600/3800 TONER CARTRIDGES

The developer roller also has an AC bias signal placed on it which makes the jump from the developer roller to the drum easier. The amount of toner on the developer roller is controlled by the doctor blade, which uses pressure to keep the amount of toner on the roller constant. Attached to the Dr. Blade is what is called a developing sheet (orange Mylar type film). This sheet improves the print quality, and helps prevent toner scatter.

As the laser exposed areas of the OPC Drum approach the developer roller, the toner particles are attracted to the drum's surface due to the opposite voltage potentials of the toner, and laser exposed areas of the OPC drum. See **Fig. 6**

The fourth stage is the transfer stage. This is where there are some large differences from monochrome printers. The first step in the transfer stage is where the transfer roller (which is located directly opposite each OPC drum), places a positive DC bias charge on the back of the ETB or transfer belt. Each toner cartridge has a separate transfer charge roller. At the same time, the paper is moving between the OPC drum and the ETB. As the ETB passes the transfer charging roller, the positive charge is picked up through the ETB, and draws the negatively charged toner off the drum onto the paper. This process is repeated for each color cartridge. As the toner piles onto the paper, the positive charge

on the paper weakens as the paper runs through each cartridge. For this reason, the charge is increased on the transfer charging roller for each successive color. See also **Figure 6**

The paper separates from the ETB belt as the belt reaches the top of its path and turns back down to start the process again. The static charge on the back of the paper is decreased with static charge eliminator. This helps stabilize the paper feed, and also prevents toner flares (spots) under low temperature and low humidity conditions. See **Figure 7**

In the fifth stage, the image is then fused onto the paper by the fuser assembly. The fuser Assembly is comprised of the upper heating assembly and lower pressure roller. The lower pressure roller presses the page up into the upper heating assembly which then melts the toner into the paper. The upper heating assembly consists of a flexible sleeve with a ceramic heating coil inside. This type of fuser affords "instant on" fusing with little to no wait time, and low power consumption. See **Figure 8**

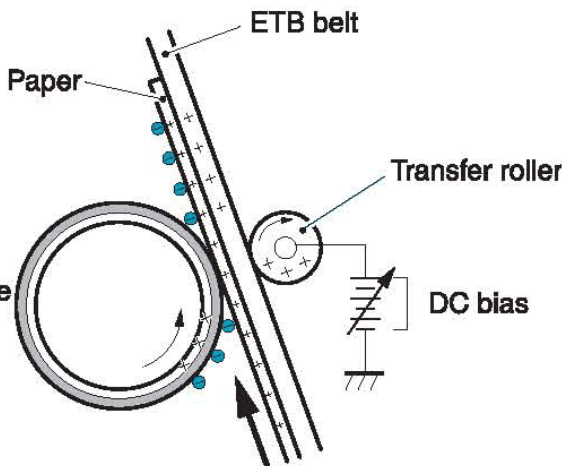

Figure 6

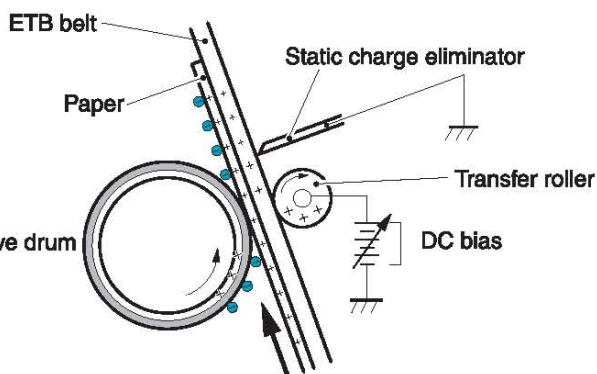

Figure 7

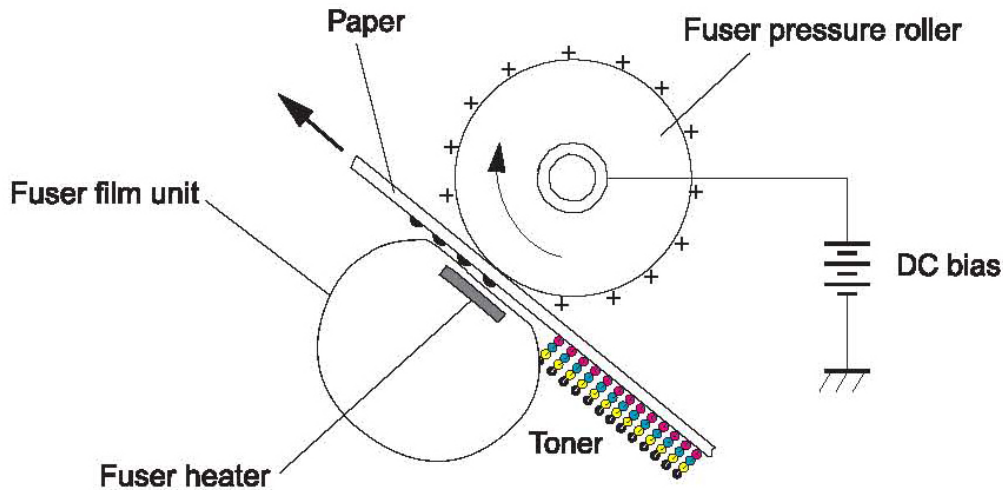

Figure 8

OPC Drum Cleaning:

The drum is cleaned after the image is transferred to the paper by the wiper blade. This part is fairly standard; the wiper blade scrapes the toner off the drum, and the recovery blade guides it into the waste chamber. These cartridges use a transfer plate to move the waste toner into the back of the cartridge.

Printer Calibration:

At the start of all this is the calibration cycle. The printer will calibrate itself whenever the printer is turned on, when a new toner cartridge is installed, after 48 hours of run time, and at 150 page intervals. Calibration consists of a solid block and halftone of each color being printed to the ETB. As the printed areas get to the top of the belt, a sensor will detect them, measure the density, and adjust the printer accordingly. All of the calibration time settings are user controllable. There are also physical calibrations of the gear train, and various rollers.

Toner Low Detection:

The last thing that needs to be discussed before getting to the actual remanufacturing is the toner level detection. The 3600 printers determine cartridge life by a number of different ways. It counts the number of OPC drum rotations, and actual amount of toner left. The amount of toner is also determined by an optical sensor that reads through a set of clear plastic lenses mounted on the supply chamber. Each of these measurements is written to the chip.

Taking test prints, cartridge troubleshooting as well as minor printer troubleshooting will be covered at the end of this article.

Required Tools

- 1) Toner approved vacuum.
- 2) A small screw driver (Common Style)
- 3) A Phillips head screwdriver
- 4) Spring Hook

Supplies Required

3000/3600/3800 Dedicated Color Toner

New replacement chip

New Long Life 3600 Drum

New Wiper Blade

New PCR [Optional]

New Doctor Blade [Optional]

Silicon caulk (Phenoseal/GE 100% silicon caulk works best)

Conductive Grease

Cotton Swabs

Shipping Lock(s)

Lint free Cloths

1) Remove the two covers over the hinge pins with a sharp sturdy razor knife. Shave the top off, and dig out around the pin until you can grasp it with your flush cutting wire cutters. Only cut deep enough so that you can remove the pin. If too deep a hole is made, the hinge pin may not fit properly, and allow the two halves to move away from each other. See

Figures 9, 9A, 10 & 11

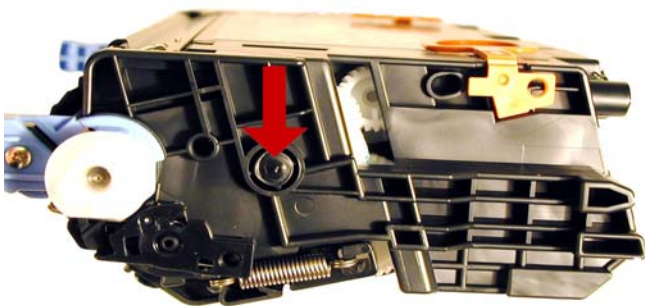

Figure 9

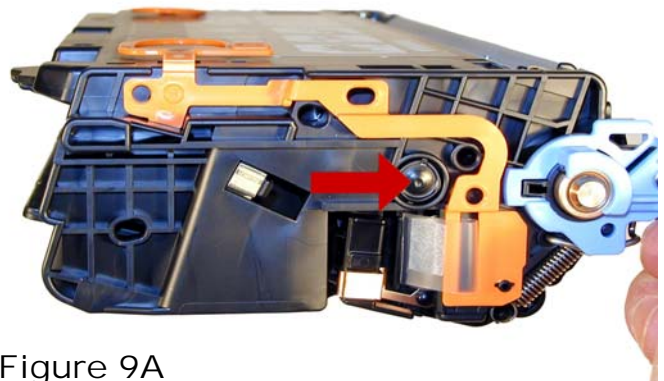

Figure 9A

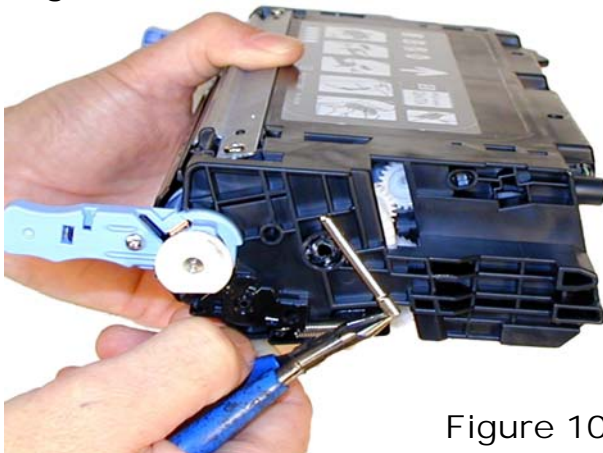

Figure 10

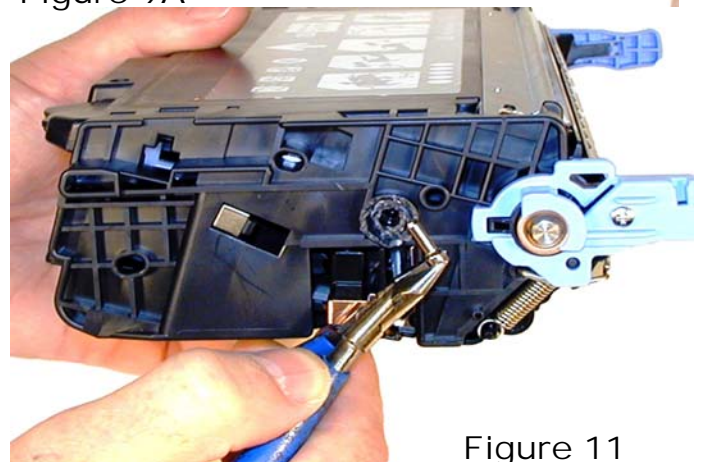

Figure 11

REMANUFACTURING THE HP CLJ 3000/3600/3800 TONER CARTRIDGES

2) Remove the 2 springs, one from each side. See **Figures 12 & 13**

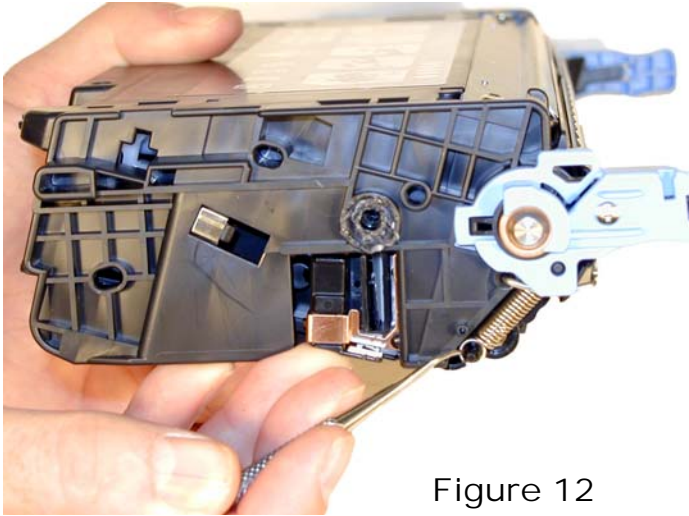

Figure 12

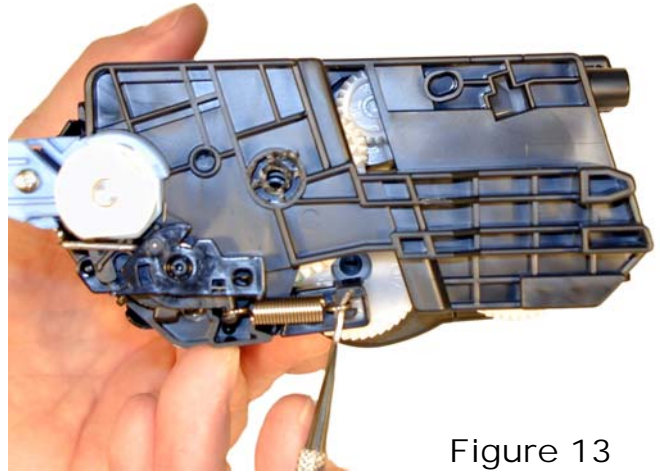

Figure 13

3) Separate the two halves. See **Figure 14**

4) On the waste chamber non-gear side remove the small Phillips head screw, and blue handle. See **Figure 15**

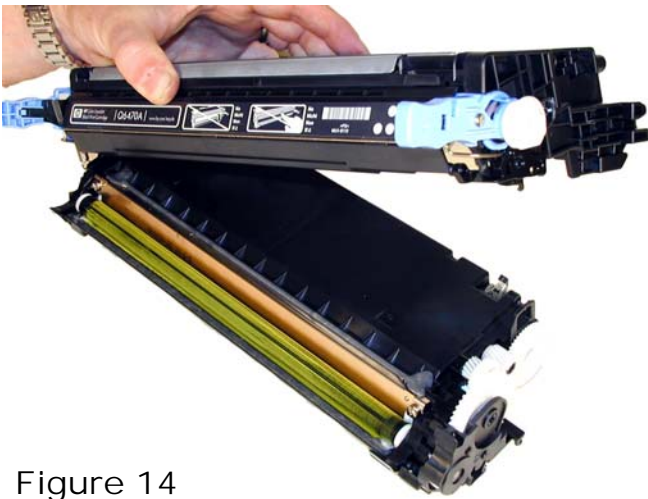

Figure 14

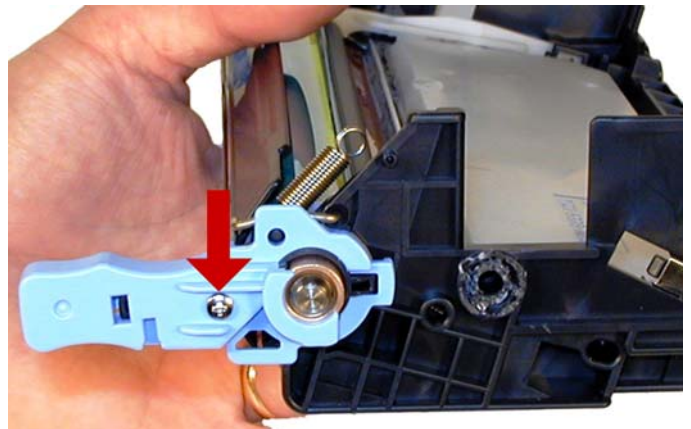

Figure 15

5) Remove the spring so it does not get lost. See **Figure 16**

6) Remove the drum cover by prying up the spring assembly, and pulling the metal bars out of their slots. Be careful not to lose the spring! See **Figures 17 & 18**

7) With the wire cutters, carefully pry the pin out from the internal drum hub. There is no need to remove the pin from the external drum drive gear. This pin is in tight and is hard to remove. Take your time, and pry not pull the pin out. See **Figure 19**

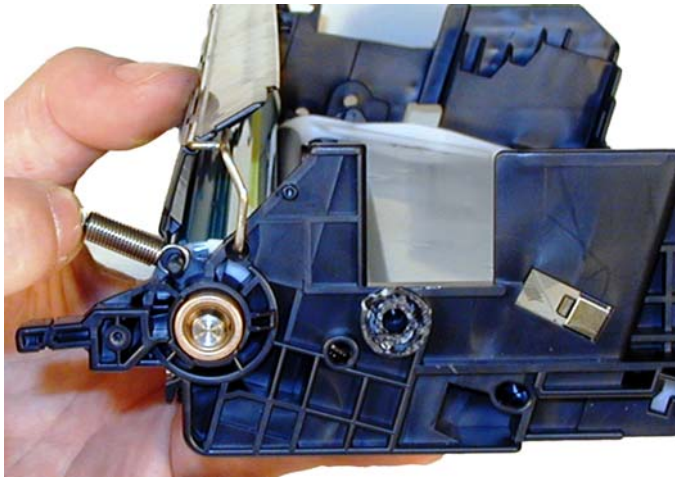

Figure 16

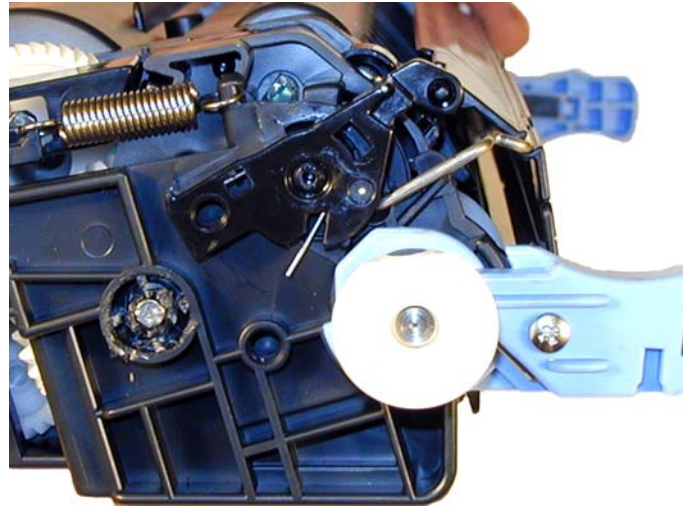

Figure 17

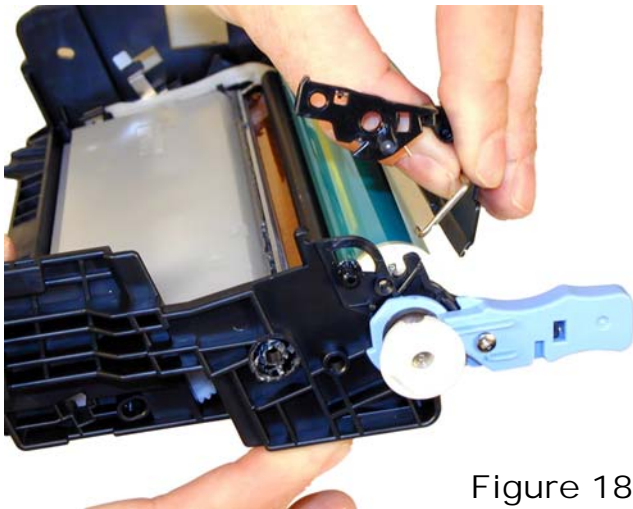

Figure 18

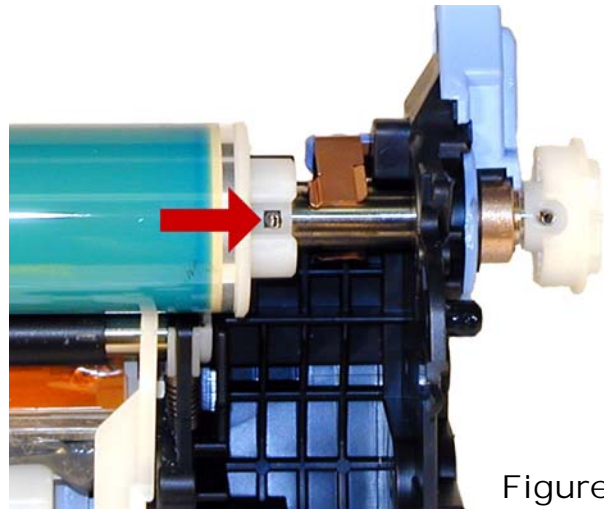

Figure 19

REMANUFACTURING THE HP CLJ 3000/3600/3800 TONER CARTRIDGES

8) Pull the drum axle out from the cartridge. Be careful of the drum as it will come loose. See **Figure 20**

9) Remove the drum. See **Figure 21**

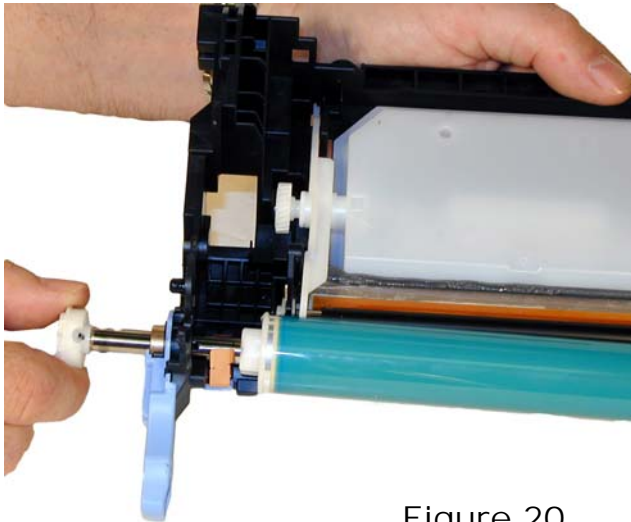

Figure 20



Figure 21

10) On the PCR, note the heavy coating of conductive grease on both sides of the roller. Normally this is only on one side. For these cartridges it needs to be on both. See **Figure 22**.



Figure 22

REMANUFACTURING THE HP CLJ 3000/3600/3800 TONER CARTRIDGES

11) Pry up the tails of the white plastic PCR holders from the cartridge. Lift up both holders, and remove the PCR. See **Figures 23 & 24**



Figure 23

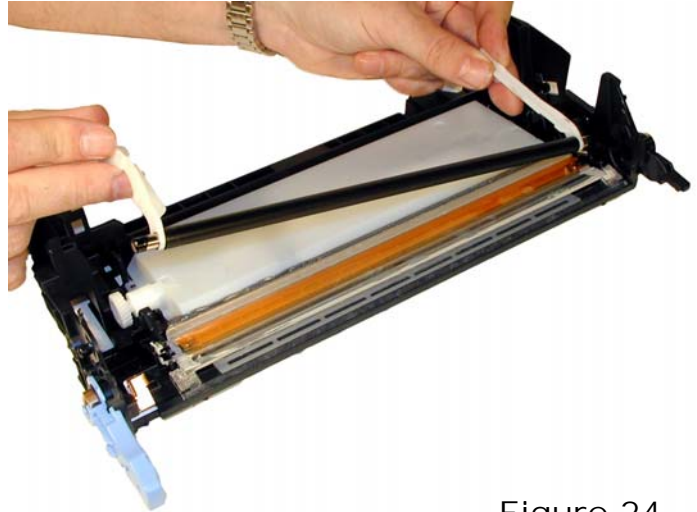

Figure 24

12) With a sharp razor knife, slide the blade along the base plastic of the orange film assembly. Remove the assembly. This must be removed to get access to the wiper blade screws. According to HP, this film assembly helps prevent toner scatter. See **Figures 25 & 26**.

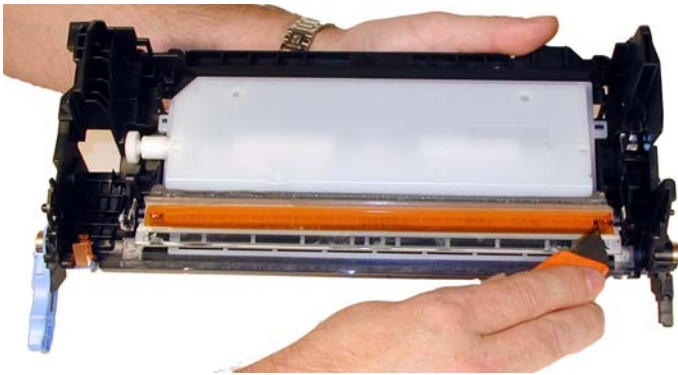

Figure 25



Figure 26

13) Remove both screws from the wiper blade. See **Figure 27**

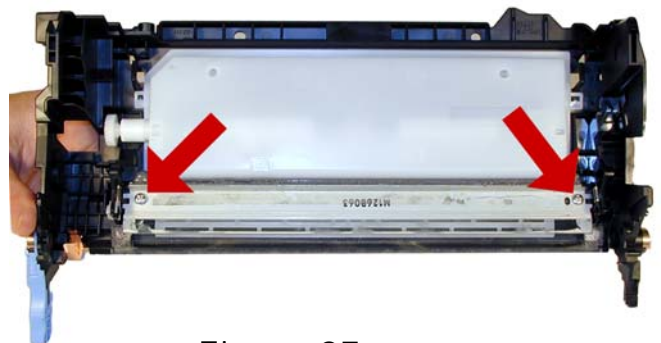

Figure 27

REMANUFACTURING THE HP CLJ 3000/3600/3800 TONER CARTRIDGES

14) Take the razor knife again and slide the blade along the back edge of the wiper blade. Keep the blade along the metal so the grey sealing material is separated from the blade. Remove the blade. See **Figures 28 & 29**



Figure 28



Figure 29

15) Dump out and vacuum any remaining toner from the hopper. You will notice that the waste chamber is actually a separate white plastic part that looks like it is held in by two clips, and can be removed. That is not the case. The chamber is glued/welded in place. The waste toner must be removed from the wiper blade opening. Try to keep the toner from getting on the grey wiper blade seal.

16) Check the grey wiper blade seal, if it is sticky, it can be re-used. If it is not, and you cleaned it with alcohol, it must be removed, and replaced with a good silicon sealer. (See supplies needed at start of article). See **Figure 30**

17) Lubricate the new wiper blade with your preferred lubricant. Install the blade and 2 screws. Make sure the wiper blade seal (which ever type you are using) seals along the back edge of the blade and around the sides. See **Figure 31**

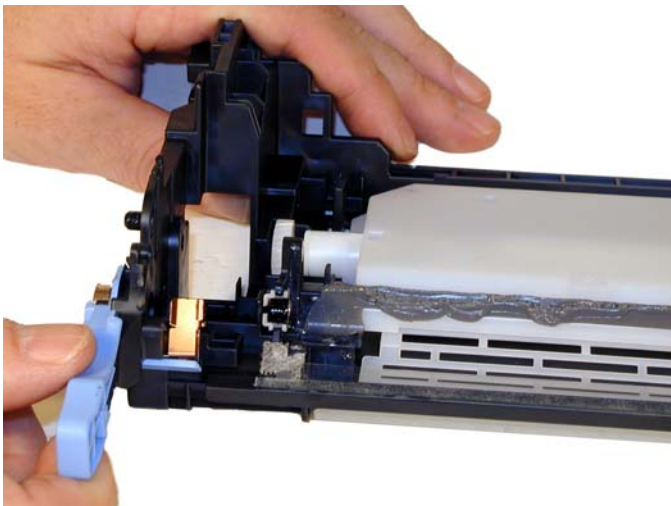

Figure 30

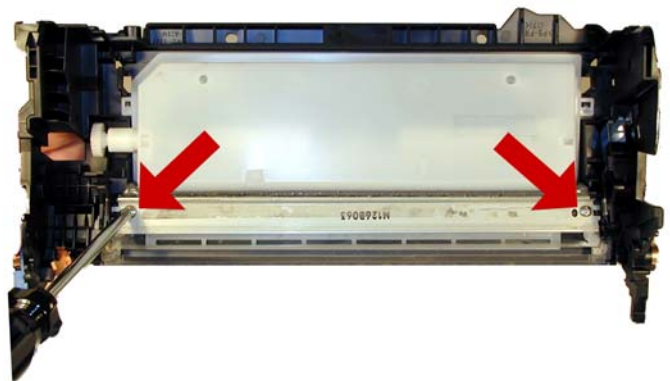

Figure 31



Figure 32

18) Install new double sided tape on the back of the orange film assembly. Install the assembly on the wiper blade in the same location it was removed from. See **Figure 32**

19) Clean off the old conductive grease from the PCR ends, and clean the PCR. Coat both ends of the PCR with new conductive grease. Place the white plastic holders on the shaft, and install the PCR and holders in the cartridge. Make sure the tails of the holders snap into place (If they come out easily, they are not in place). See **Figures 33, 34, & 35**

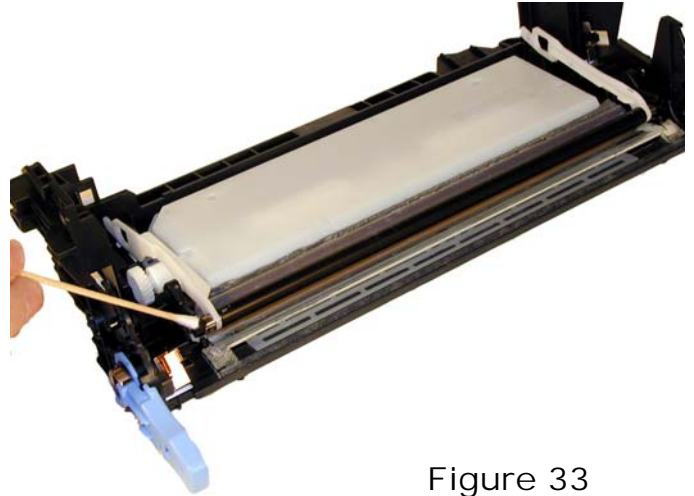

Figure 33

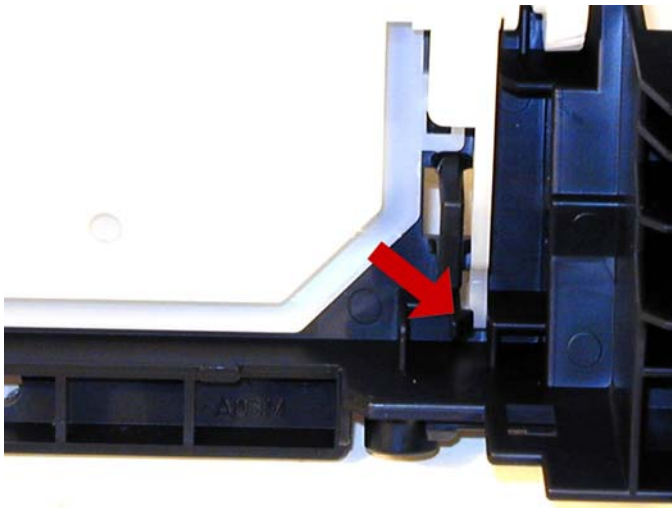

Figure 34

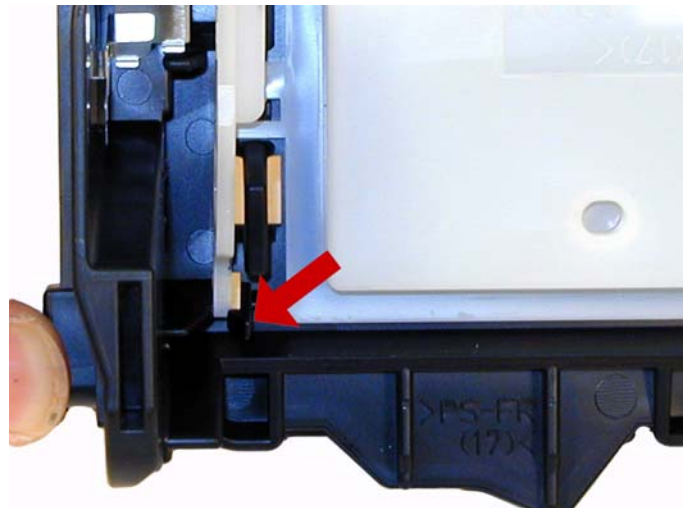

Figure 35

REMANUFACTURING THE HP CLJ 3000/3600/3800 TONER CARTRIDGES

20) Install the drum in the cartridge, large hub side to the copper contact side. See **Figure 36**

21) Slide the drum axle in from the gear side. Make sure you do not damage the copper drum contacts. Both tabs must be in contact with the axle. See **Figure 37**

22) Align the drum hub and axle so that the holes line up. Insert the metal pin. Make sure the pin is centered on the axle.



Figure 36

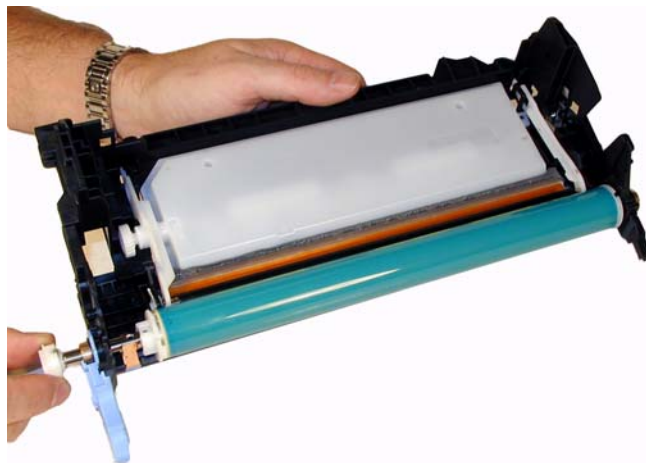

Figure 37

If the pin sticks out too far on one side, there is a plastic block on the waste chamber that will stop the drum from turning. Spin the drum a few rotations to make sure everything is OK. See **Figures 38 & 39**

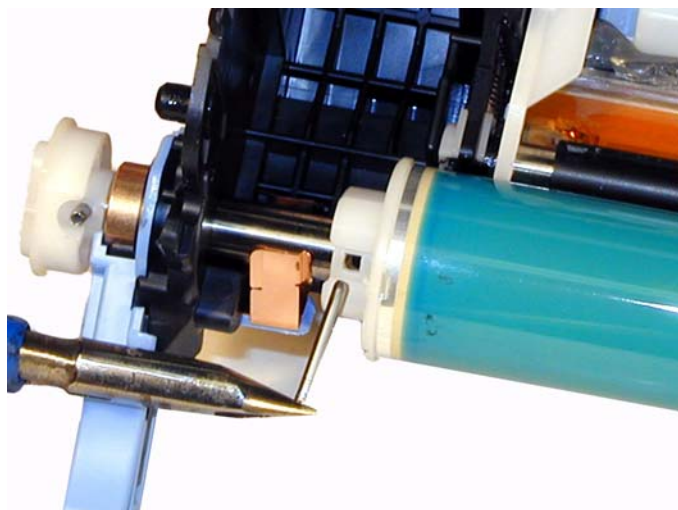

Figure 38

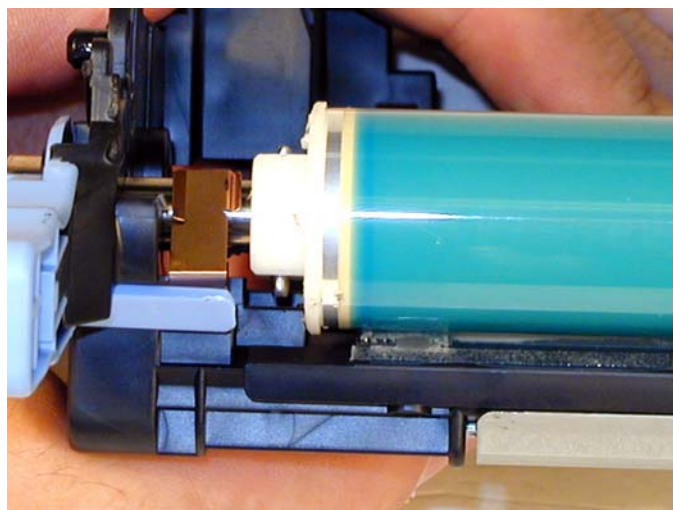
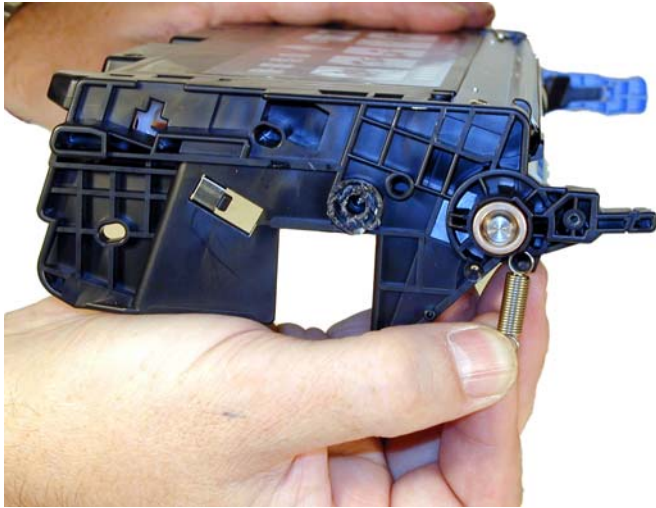

Figure 39

REMANUFACTURING THE HP CLJ 3000/3600/3800 TONER CARTRIDGES

23) On the non-gear side, install the spring on the post. See **Figure 40**

24) Install the blue handle and screw. See **Figure 41**



25) Place the waste chamber aside. **Figure 40**

Figure 41

26) On the contact side of the toner supply, remove the 2 screws and end cap. See **Figures 42 & 43**

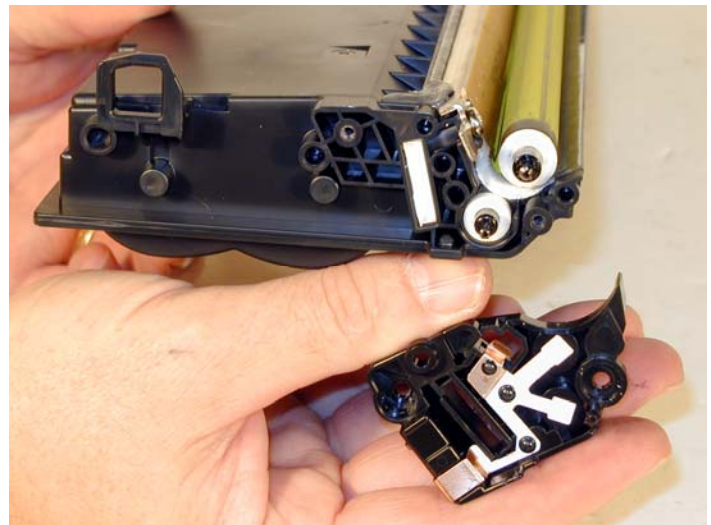
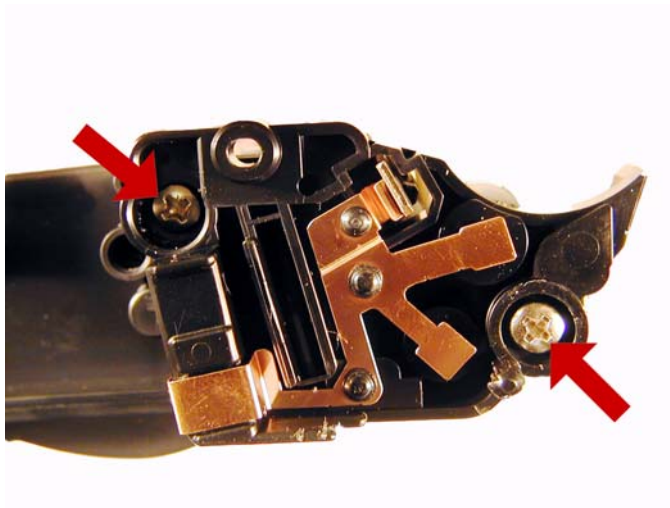

Figure 42

Figure 43

27) Slide the developer roller out from the cartridge. There is no need to remove the gear side end cap or gears. See **Figures 44 & 45**

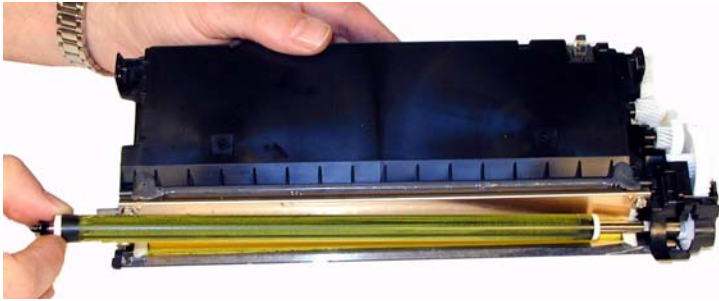

Figure 44

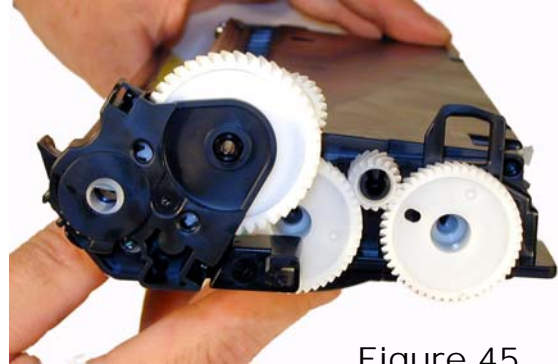

Figure 45

28) Remove the two screws on the doctor blade. See **Figure 46**

29) On the back edge of the doctor blade, slide a sharp razor knife along the back edge of the blade separating the grey sealing material from the blade. Carefully lift the blade off the cartridge. Be careful not to bend the blade! If the blade does not lift off easily, there may be some sealing material under the blade and you need to run the knife under the blade as well. See **Figures 47 & 48**



Figure 46



Figure 47

30) Vacuum out any remaining toner from the hopper. We don't recommend dumping it out as the toner will get all over the hopper. It is hard to clean off.

31) Vacuum the feed roller clean. Until new felt seals are available for the developer roller, we do not recommend that the feed rollers be removed. Re-using old seals that have been removed may cause leaks See **Figure 49**



Figure 48

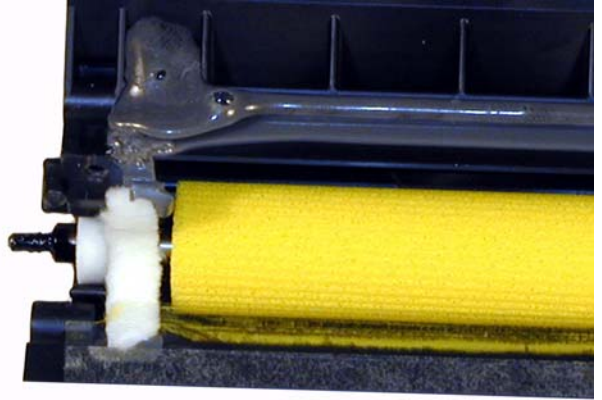

Figure 49

32) These cartridges do not have a fill plug and must be filled through the developer roller opening. Fill the hopper with the correct amount of dedicated 3600 toner. See **Figure 50**

33) When a seal becomes available you will need to install it now.

34) Check the grey sealing material to see if it is sticky. If not, clean it with alcohol. If that does not work, remove the material, and replace it with a good quality silicon caulk. See **Figure 51**



Figure 50

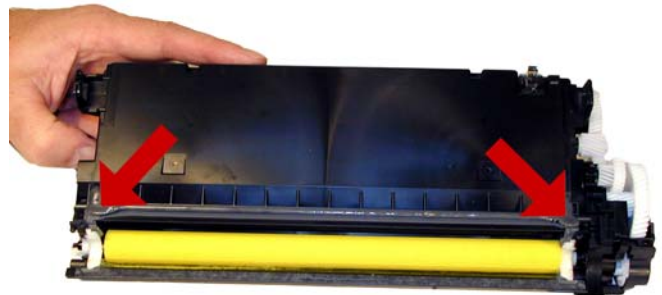

Figure 51

REMANUFACTURING THE HP CLJ 3000/3600/3800 TONER CARTRIDGES

35) Take the Dr. Blade and check to see if it is bent in any way. If it is, replace it. This can happen sometimes when the blade is removed. Install the doctor blade and two screws. Make sure the blade is sealed at the back edge. See **Figures 52 & 53**



Figure 52

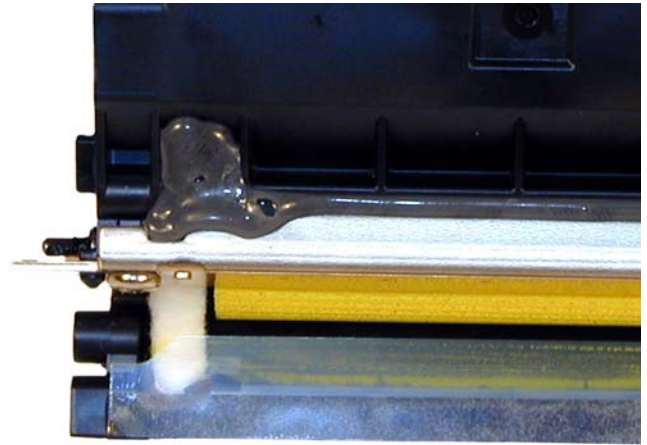

Figure 53

36) Wipe the developer roller down with a clean lint free cloth. We do not recommend that any chemicals be used at this time. Testing is still on going to see what if anything can be used. Install the cleaned developer roller in the hopper keyed end first. Spin it until it is fully seated in the drive gear. See **Figures 54 & 55**

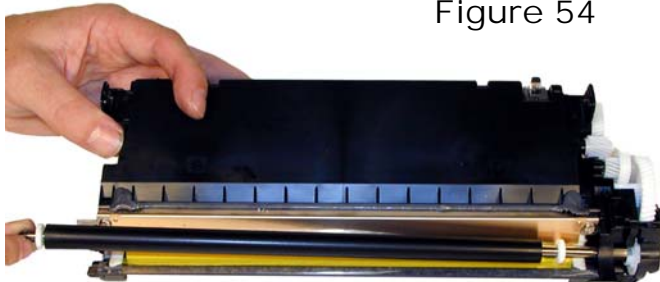

Figure 54

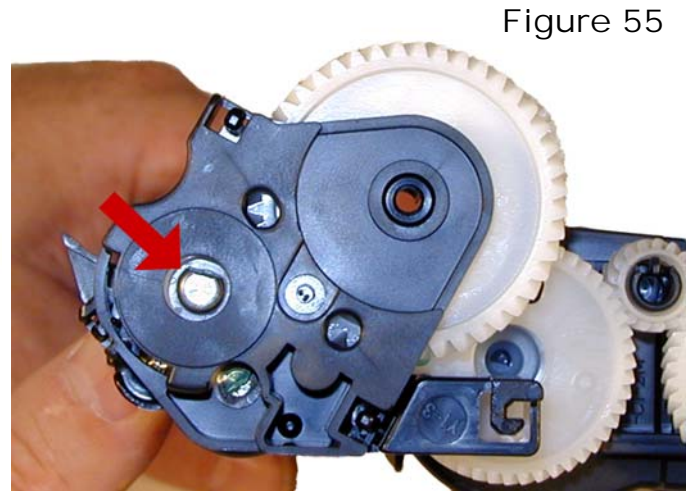

Figure 55

37) Clean the old conductive grease from the contact end cap, and replace with new. Use the same amount of grease that you removed. If too much is used, it can attract toner dust and actually insulate the contact instead of enhance it.. Install the contact end cap and two screws. See **Figure 56**

38) Place the supply chamber onto the waste chamber. See **Figure 57**

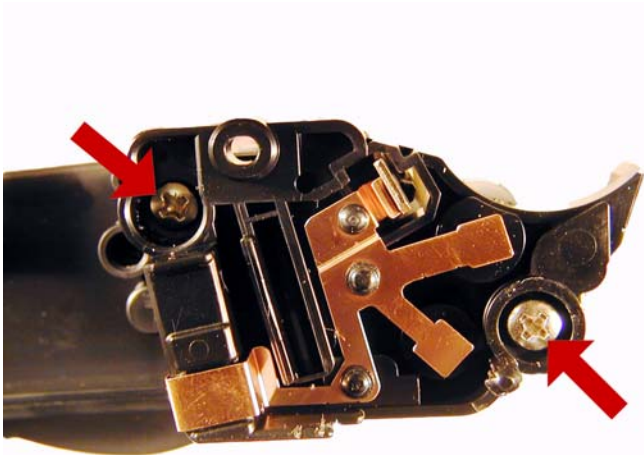

Figure 56



Figure 57

39) Align the two halves and install the hinge pins, short pin to the non-gear side, and long pin to the gear side. See **Figures 58 & 59**

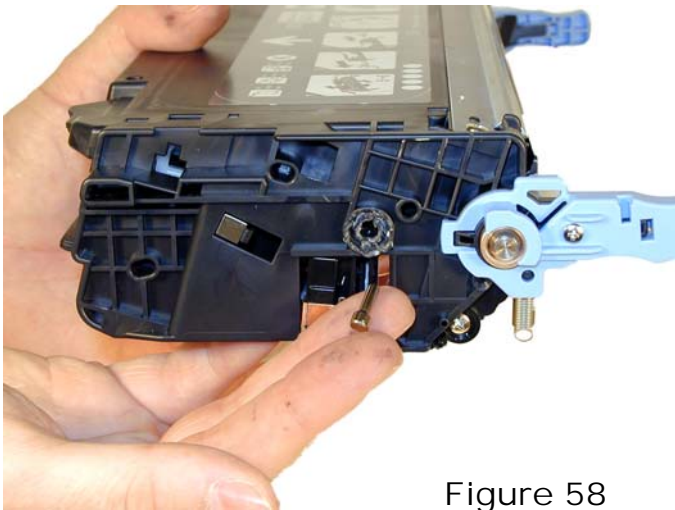

Figure 58

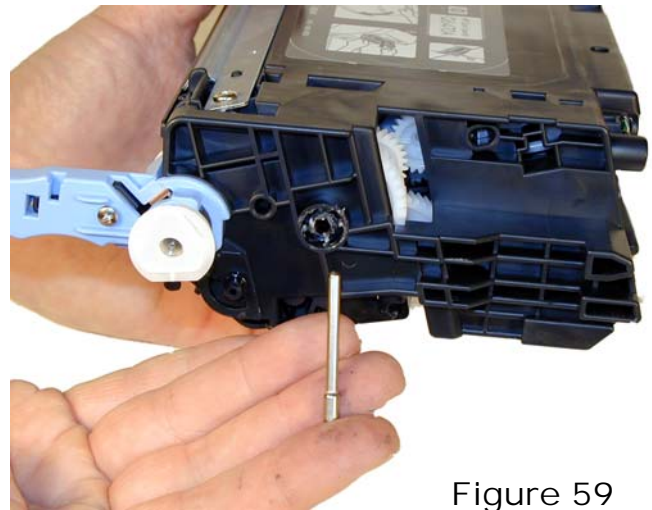

Figure 59

40) Install the springs on each side of the cartridge. See **Figures 60 & 61**

41) Install the drum cover. Set the spring in the holder as shown. Snap the holder in place and install the metal bar into the proper holes on each side. See **Figures 62, 63 & 64**

42) Release the tail of the spring so that the cover closes properly. See **Figure 65**

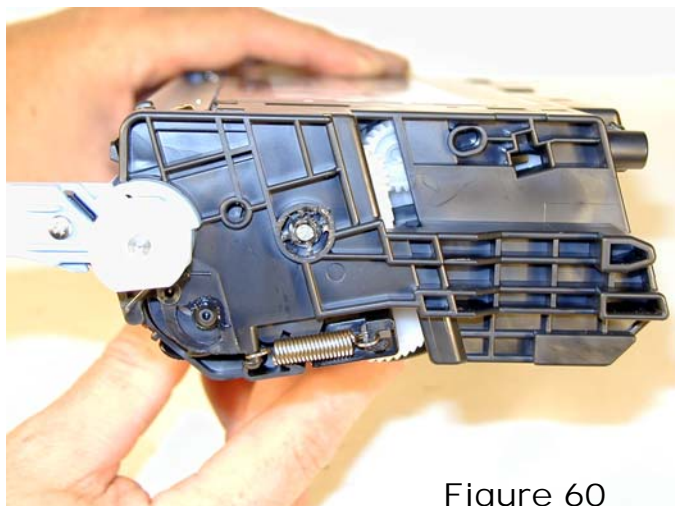

Figure 60

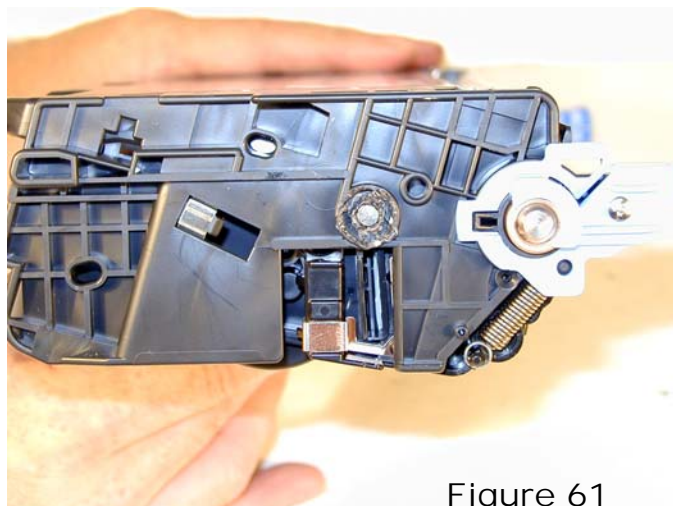

Figure 61

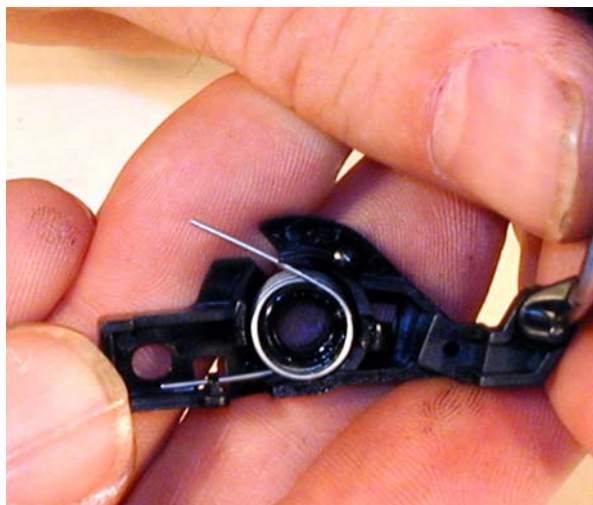

Figure 62

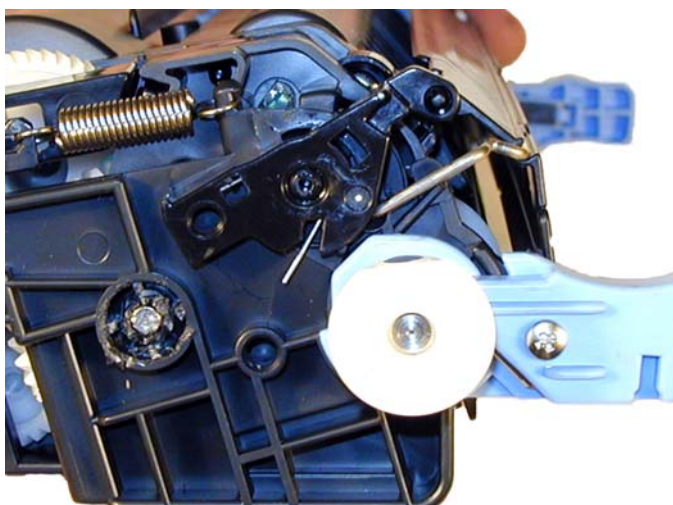

Figure 63

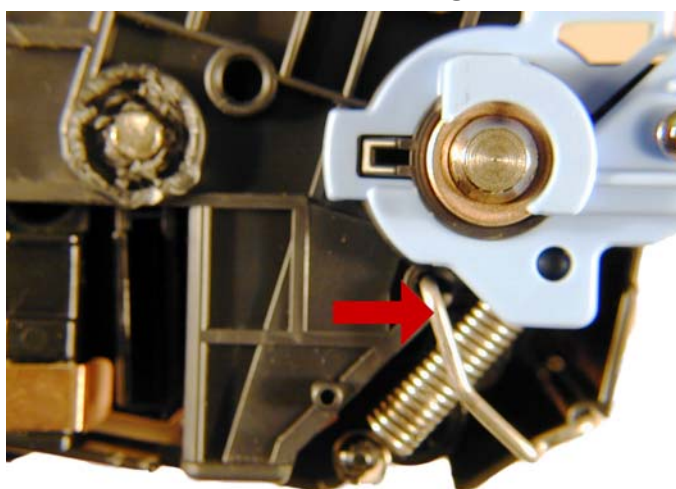

Figure 64



Figure 65

REMANUFACTURING THE HP CLJ 3000/3600/3800 TONER CARTRIDGES

43) Install the shipping locks on each side of the cartridge. If the cartridge is to be used right away, they are not necessary, but if the cartridge might sit on a shelf for a while, they should be installed. They keep the developer roller from getting a flat spot, which will cause horizontal voids in the print. See **Figures 66 & 67**

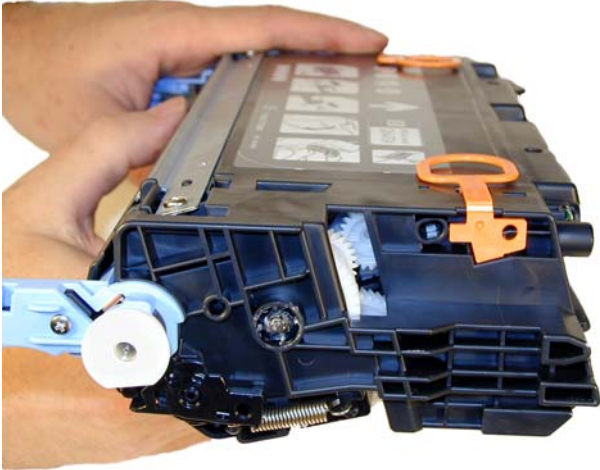

Figure 66

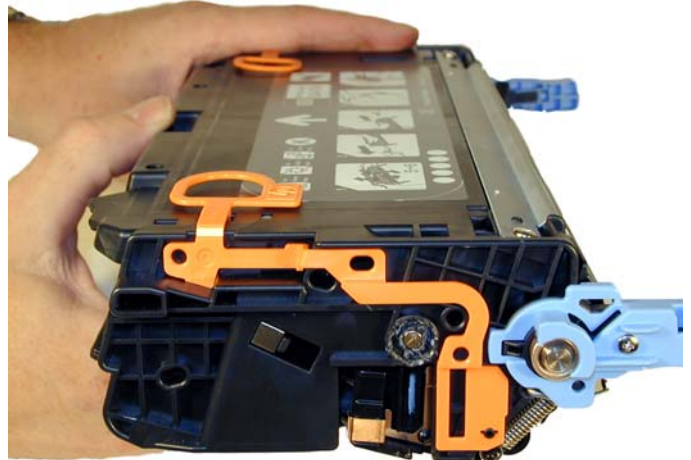

Figure 67

44) Clean the two clear plastic Toner low lenses on the supply chamber. See **Figures 68 & 69**

44) Replace the chip on the cartridge. Be sure to use the correct color chip for your cartridge. See **Figure 70**



Figure 68

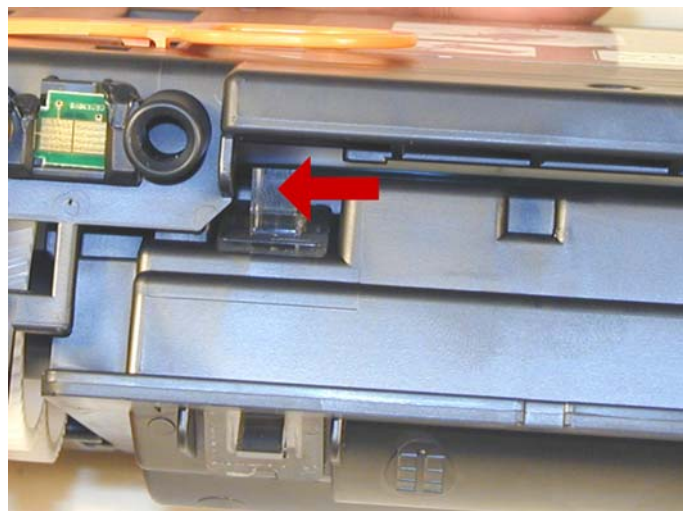
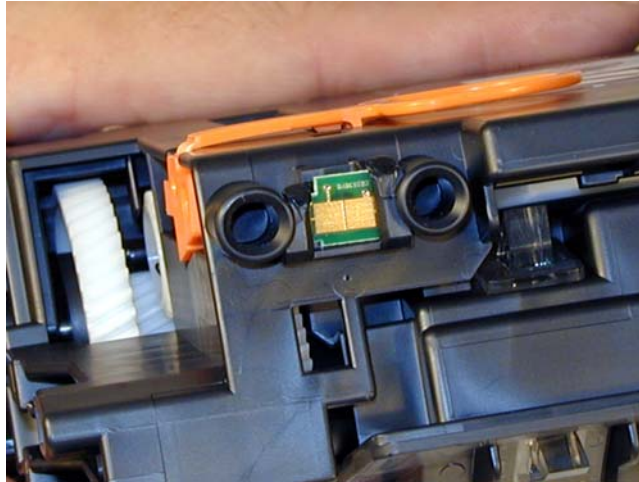

Figure 69

Figure 70



Taking Test Prints

Demo Page

Press the MENU button on the printer

Press the down arrow until "INFORMATION" appears on the display. Press SELECT.

Press the down arrow until "PRINT DEMO" appears on the display. Press SELECT.

Configuration Page

Press the MENU button on the printer

Press the down arrow until "INFORMATION" appears on the display. Press SELECT.

Press the down arrow until "CONFIG REPORT" appears on the display. Press SELECT.

Supplies Status Page

Press the MENU button on the printer

Press the down arrow until "INFORMATION" appears on the display. Press SELECT.

Press the down arrow until "PRINT SUPPLIES STATUS PAGE" appears on the display. Press SELECT.

REMANUFACTURING THE HP CLJ 3000/3600/3800 TONER CARTRIDGES

Usage Page (CLJ 3000 and 3800 series only)

Press the MENU button on the printer

Press the down arrow until "INFORMATION" appears on the display. Press SELECT.

Press the down arrow until "PRINT USAGE PAGE" appears on the display. Press SELECT

(This page shows a page count for each size page printed, # of one sided pages and duplexed pages, and the average percentage of coverage for each color.)

Repetitive Defect Chart:

Developer Roller Sleeve	27mm	
Primary Charge Roller	27mm	
Registration Roller (inside)	35mm	
Registration Roller (outside)	36mm	(Marks on back of page)
Transfer Rollers	44mm	(Marks on back of page)
Fuser Sleeve	75mm	
OPC Drum	76mm	
Fuser Pressure Roller	79mm	(Marks on back of page)

Cartridge Troubleshooting:

Primary Charge Roller (PCR); The primary charge roller if dirty will show on the test print as vertical gray streaks down the page, or as a gray background throughout the page. If there is any physical damage, it will repeat at intervals of 27mm.

A Dirty PCR Connection will result in dark black horizontal bars across the page, or as shading throughout the page.

A Scratched Drum will show up as a very thin, perfectly straight line that runs from the top to the bottom of the test page.

A Chipped Drum will result in a dot or series of dots that repeat at 76mm intervals

A Damaged Developer Roller Sleeve will either leave a mark or a blank spot (depending on the type of damage) at intervals of 27mm.



USA Sales: T 800.221.3516 F 888.791.9188
International Sales: T +1 631.590.1040 F +1 631.218.3285

www.summitechnologies.com

Page

A Light Damaged Drum will show up as a shaded area on the test print that should be white. Again this will repeat at intervals of 76mm.

A Bad Wiper Blade will result in vertical gray lines down the page, or as shading across the entire page. In either case there will be a film of toner on the drum surface.

Some of the more common Printer Error Messages:

10.XX.YY Supply Memory Error: Chip cannot be read or cartridge is not properly installed

For XX = 00 Bad Chip

For YY = 00 Black cartridge

For YY = 01 Cyan cartridge

For YY = 02 Magenta cartridge

For YY = 03 Yellow cartridge

10.92.YY Cartridges not engaged

For YY = 00 Black cartridge

For YY = 01 Cyan cartridge

For YY = 02 Magenta cartridge

For YY = 03 Yellow cartridge

10.94.YY Remove shipping locks from all cartridges: At least one cartridge still has a shipping lock installed

50.X Fuser Error

For X = 1 Low Fuser Temp.

For X = 2 Slow Fuser

For X = 3 High Fuser Temp.

For X = 4 Faulty Fuser.

For X = 7 Fuser pressure release mechanism failure.

For X = 8 Low fuser temperature (sub thermistor).

For X = 9 high fuser temperature (sub thermistor).

51.2X Printer Error

For X = 0 Black Scanner error

For X = 1 Cyan Scanner error

For X = 2 Yellow Scanner error

For X = 3 Magenta Scanner error

Calibrate Now

Press the MENU button on the printer

Press the down arrow until "CONFIGURE DEVICE" appears on the display. Press SELECT.

Press the down arrow until "PRINT QUALITY" appears on the display. Press SELECT

Press the down arrow until "FULL CALIBRATE NOW" appears on the display.

Press the "SELECT" to start the calibration.